

How to install the tracker

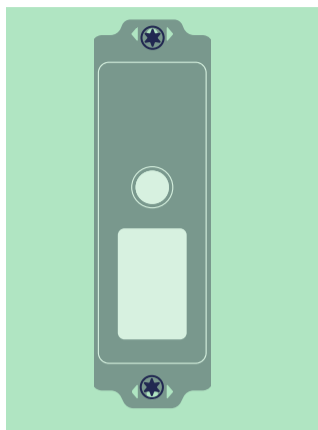

Sensolus recommends to install the tracker with rivets or bolts. For alternative fixation methods such as magnets please contact the Sensolus Help Desk.

support@sensolus.com or +32.9.298.09.43

Install with rivets

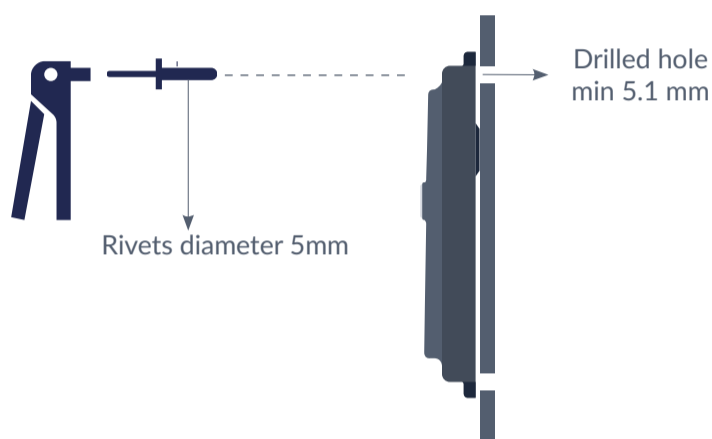

Rivets are advised as they are more secure and tamper proof.

The height of the casing where the mounting holes are located is 8mm.

We recommend Gesipa Blind Rivets Aluminium/Steel Standard Flat Head 5 x 16 mm.

Install with bolts

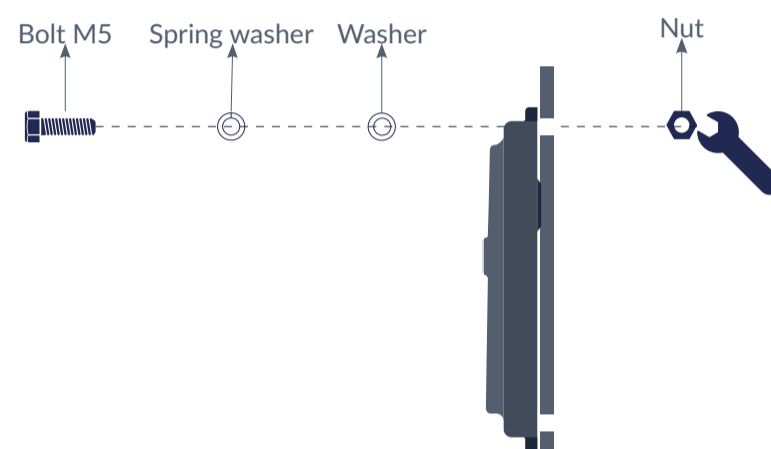

1. It is recommended to use M5 bolts and to use thread locking glue on the bolts. We recommend Loctite Thread Locker Blue 242.

2. Protect the casing with a washer and use a spring washer to mitigate the effects of vibration and temperature variations.

3. The maximum allowed torque is 3.5NM for an M5 x 12 mm screw used with a washer. Applying more torque may severely damage the tracker's casing.

Installation advice



The recommended orientation is vertical (upright) with the arrows on the sticker pointing upwards.



The second best orientation is horizontal (sideways).



Do **not** mount the tracker upside down, with the sticker on top.



Do **not** mount the tracker horizontally, facing upwards.

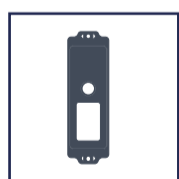

Avoid blocking the tracker's view with metal or carbonfibre walls. They weaken or block the radiofrequency signals.



Place the tracker as high as possible on the asset to ensure good network coverage.



Make sure the mounting surface is **flat and clean**, for a strong and durable bond and to secure the tamper function will work.



Do not install the tracker on parts that receive frequent shocks or vibrations.



You can place the tracker in a protected location, but never with metal or carbonfibre above the tracker.

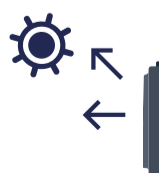

Make sure the tracker has a clear view on the sky.



Avoid placing the tracker in a place that can collect water.



Do not mount on round surfaces, **this will impact the tamper functionality.**

Tracker activation

- Activation of the trackers is preferably done with clear skies, and not inside (e.g. factory or warehouse). Trackers are not activated when delivered to your premises. Their subscription in the platform will start within six month of purchase. We offer 2 ways to activate the tracker. Magnet activation or tamper button activation.

Magnet activation

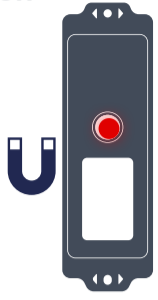

Step 1

Hold a magnet for about 5 seconds on the left of the asset tracker. You will see a **red LED**. Do not remove the magnet yet.



Step 2

When the **green LED is blinking** you can remove the magnet. Your tracker is ready for use.

Tamper button activation

This type of activation is done automatically when the tracker is installed properly on an flat surface and the tamper button is pressed continuously. The tamper button will only work one time when installed on a solid surface. When pressed and unpressed multiple times the tamper button breaks and it does not behave anymore as designed.



Step 1

Press the tamper button and wait 5 seconds. Keep pressing the tamper button.

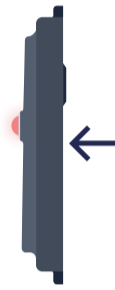

Step 2

You will first see a **red LED**. Keep pressing the tamper button for 55 seconds.



Step 3

The green LED starts to blink for a few seconds.

Keep pressing for 60 seconds

Force new configuration download on the tracker when active



Step 1

Hold a magnet on the left side of the casing for about 5 seconds. You will see a **green LED**.



Step 2

LED is **green and red**. Remove the magnet.



Step 3

LED blinks **green for min 30 seconds**.



Step 4A

Either you will see a **green LED**. New configuration received.

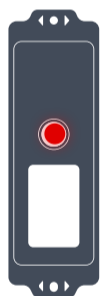

Step 4B

Or you will see a **red LED**. No new configuration received.

Get device status

- Put the magnet on the left side of the tracker for **less than 5 seconds**
- The possible LED feedback options are:



Red LED

Tracker is **not activated**



Green LED

Tracker is **activated**



No LED

Tracker is **not functioning**

(probably dead battery -> contact support)



Red LED is **blinking**

Tracker is **busy**